

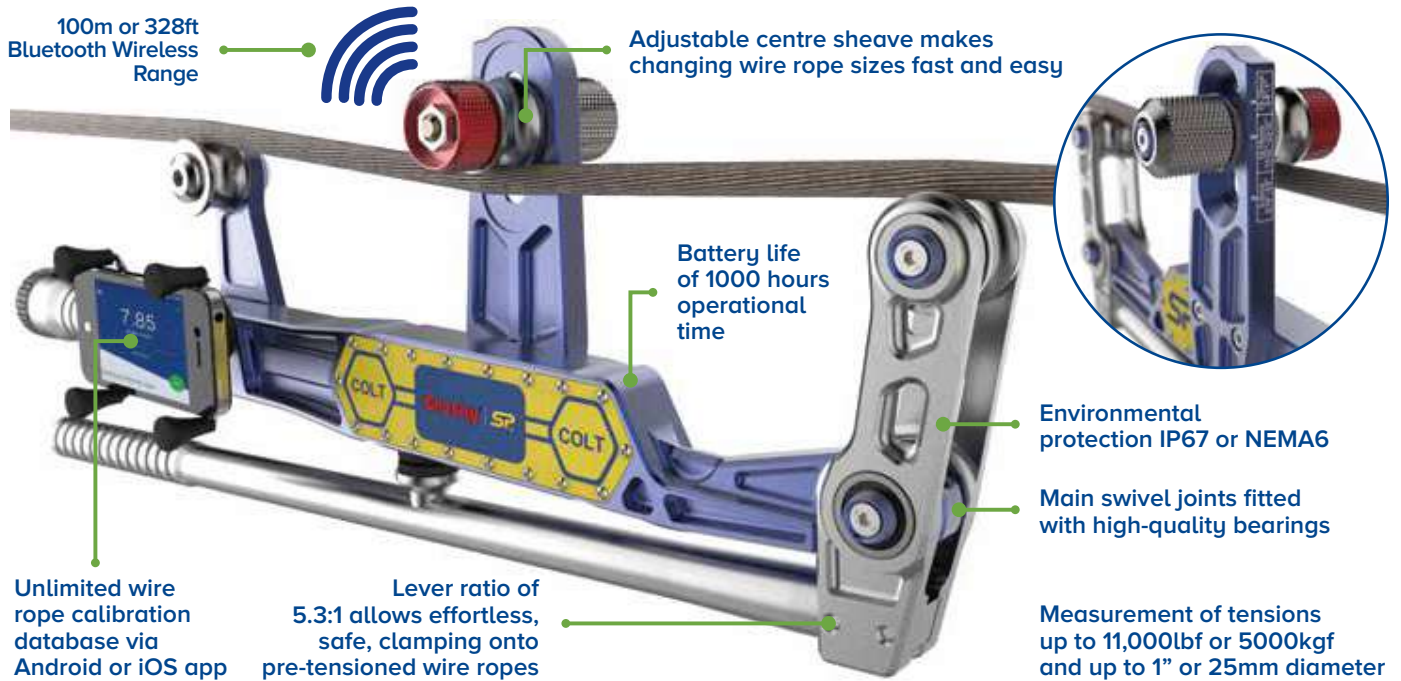

Clamp On Line Tensionmeter



The Straightpoint COLT is a lightweight wire rope tension meter, for fast and accurate measurement of tensions up to 11,000lb or 5000 kg and up to 1" or 25mm diameter.

Manufactured using an integral, high accuracy, Bluetooth module, the COLT transmits load data wirelessly to any smart device running our free Android or iOS app.

Constructed from aerospace grade aluminium, the COLT digital tensiometer is lightweight and easy to handle. Its main operational application is to be attached to wires/cables that are already under tension. Once in place, it allows the operator to quickly check tension on cables or wire ropes set at any angle.

A built-in magnetic smart device holder allows the COLT to be used as a traditional tension meter with on board display, or the smartphone can be handheld or mounted elsewhere.

Supplied in a purpose made carry case, the COLT is portable and utilises standard alkaline batteries, making it perfect to carry out on-site cable tension testing anywhere in the world.

An optional calibration verification tool (CVT) allows the operator to self-check and verify calibration accuracy, in the field, if required.

Features and benefits:

- Unlimited wire rope calibration database via Android or iOS app
- Main swivel joints fitted with high-quality bearings
- Lever ratio of 5.3:1 allows effortless, safe, clamping onto pre-tensioned wire ropes
- Wireless Bluetooth 4.2 enabling operator to stand a safe distance away, up to 100 metres or 328 feet
- Quick intuitive adjustable centre sheave makes changing wire rope sizes fast and easy
- No easily broken external antennae
- High waterproof resistant design IP67 or NEMA6 for all weather use
- Massive battery life of 1000 hrs operational time
- As the library of wire rope diameters and constructions is increased each app user will benefit when they update free of charge

Tower Mode:

- Records GPS coordinates
- Logs the local temperature and windspeed from local NOAA
- Ability to also allow elevation of wire rope to be inputted into log

Applications:

- Guy wire maintenance on cell towers, bridges, flare stacks, antennas and masts
- Guy wire Tower Plumb and Tension
- EHS guy wire, Turnbuckle tensioner
- Wire rope installations, comparing, equalising and measuring
- Architectural wire rope installations
- Median cable barrier tensioning
- Utility cable overhead line monitoring
- Elevator hoist, governor and compensating wire rope maintenance
- Zip lines and assault course testing
- Fall arrest systems
- Metro, tram and rail transit electric wires, and catenary testing
- Ski lifts
- Wire rope tie downs on vessels (using Tirfor)
- Testing tension of ship mast wire ropes.
- Tensioned trellis systems
- Measuring Line Sag

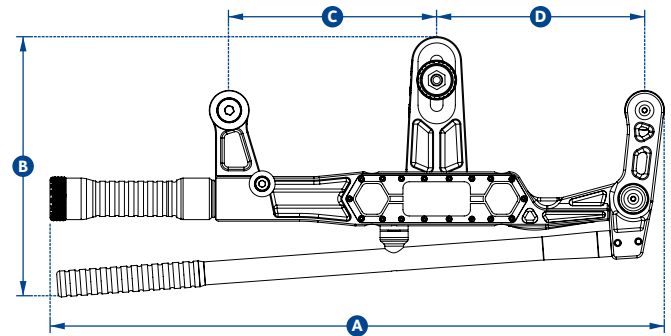

Part Numbers	
SP	COLT5T
Crosby	2789000
Max Load	5000kg 11000lbs
Resolution	10kg 20lb
Units	kg, lbs, tonne and kN
Min Wire Rope Ø	Ø5mm Ø3/16"
Max Wire Rope Ø	Ø25mm Ø1"
Max Line Reduction	5mm with a Ø10mm wire rope 7/32" with a Ø3/8" wire rope
Wire Rope Database	Infinite via Android 4.4 or iOS 8.0 app
Weight	3.5kg 7.7lbs
Battery Type	2 x 'C' cell batteries
Battery Life	1000 hours Bluetooth transmission time
Operating Temp.	-25°C to +70°C -13°F to +158°F
Protection	IP67 NEMA6
Accuracy	±3% of full scale if wire rope Ø and construction known
Communication	Bluetooth 4.2
Dimension A	589mm 23.2"
Dimension B	254mm 10"
Dimension C	200mm 7.9"
Dimension D	200mm 7.9"

Specifications assume COLT used on a wire rope with a fixed and flexible end

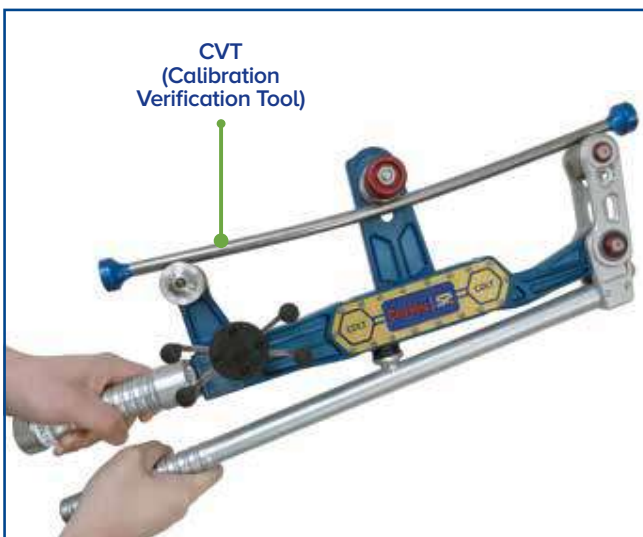

Optional for purchase: CVT (Calibration Verification Tool)

In order to ensure that the measurements of the COLT are as accurate as possible, SP supply a calibration verification rod, specifically designed for this purpose.